

UVCI-AR0821-SL

TechNexion
INNOVATORS OF TECHNOLOGY

- onsemi AR0821 8MP Rolling Shutter Sensor
- 4K HDR Imaging Capabilities
- Designed for Low Light Applications
- S-Mount for Interchangeable Lenses
- UVC USB Type-C 5 Gbps Connector
- Plug & Play with Windows & Linux OS
- VizionViewer™ configuration utility
- VizionSDK for custom development



VizionSDK VizionViewer™

Camera Information

CMOS Sensor	onsemi AR0821
Active Pixels	3848 (H) x 2168 (V) = 8MP
Pixel Size	2.1 μm x 2.1 μm
Illuminated Type	Back Side Illuminated (BSI)
Maximum S/N Ratio	41.8 dB
Optical Format	1/1.7" (Diagonal 9.25 mm)
Shutter Type	Rolling Shutter
Chromaticity	Color
HDR Support	Yes
Maximum Frame Rate (MJPEG)	3840 x 2160 @ 30 fps 2560 x 1440 @ 60 fps 1920 x 1080 @ 60 fps 1280 x 720 @ 60 fps 640 x 480 @ 60 fps
Maximum Frame Rate (UYVY)	3840 x 2160 @ 15 fps 2560 x 1440 @ 30 fps 1920 x 1080 @ 60 fps 1280 x 720 @ 60 fps 640 x 480 @ 60 fps
Output Format	MJPEG (JPG) UYVY

Camera Interface

Connector	USB Type-C 5 Gbps
-----------	-------------------

Power

Supply Voltage	5V \pm 5%
Power Consumption	3840 x 2160 @ 15 fps \leq 1.6W
Standby Power	\leq 0.1W Standby

Software Support

Operation System	UVC Plug-and-play Windows 10/11 Linux Yocto
Software	VizionViewer™
Development SDK	VizionSDK

Environmental and Mechanical

Dimensions	24.5(W) x 24.5(H) x 25.6(D) mm
Weight	\leq 23 grams
Operating Temperature	- 30°C to + 70°C

Certification and Compliance

Certification	Compliant with CE / FCC / RoHS / REACH directives
---------------	---------------------------------------------------

Spectral Characteristics

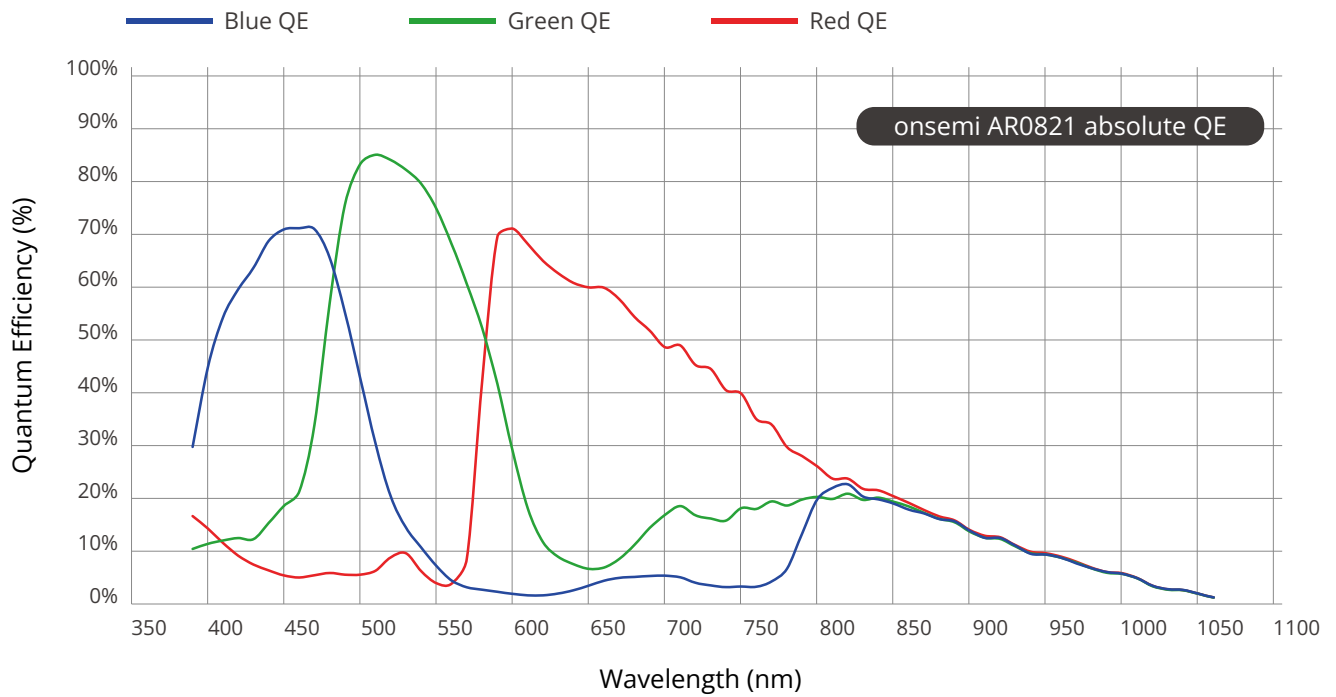

Block Diagram

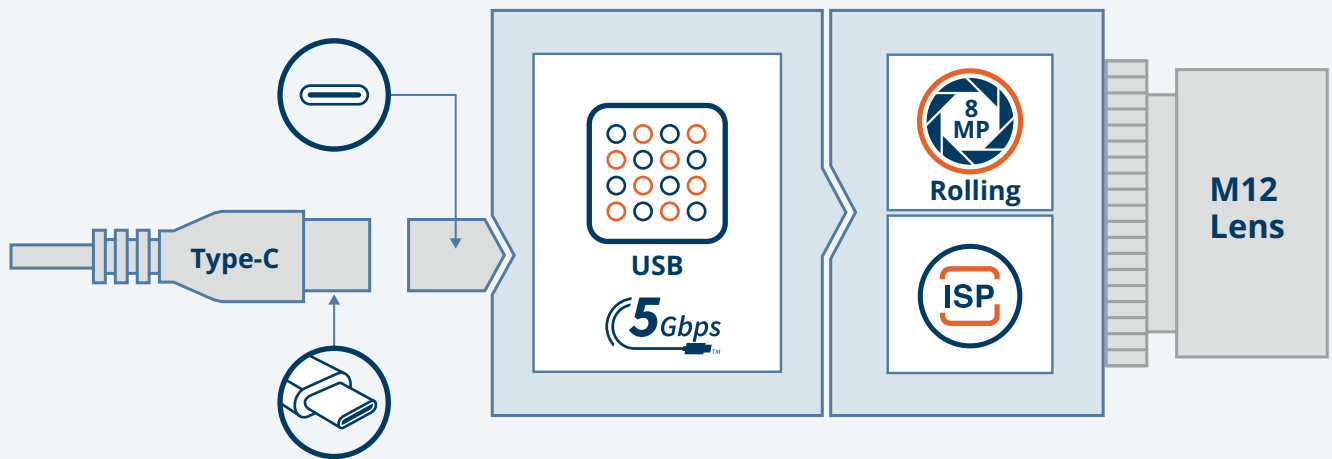

Dimensions (units in mm)

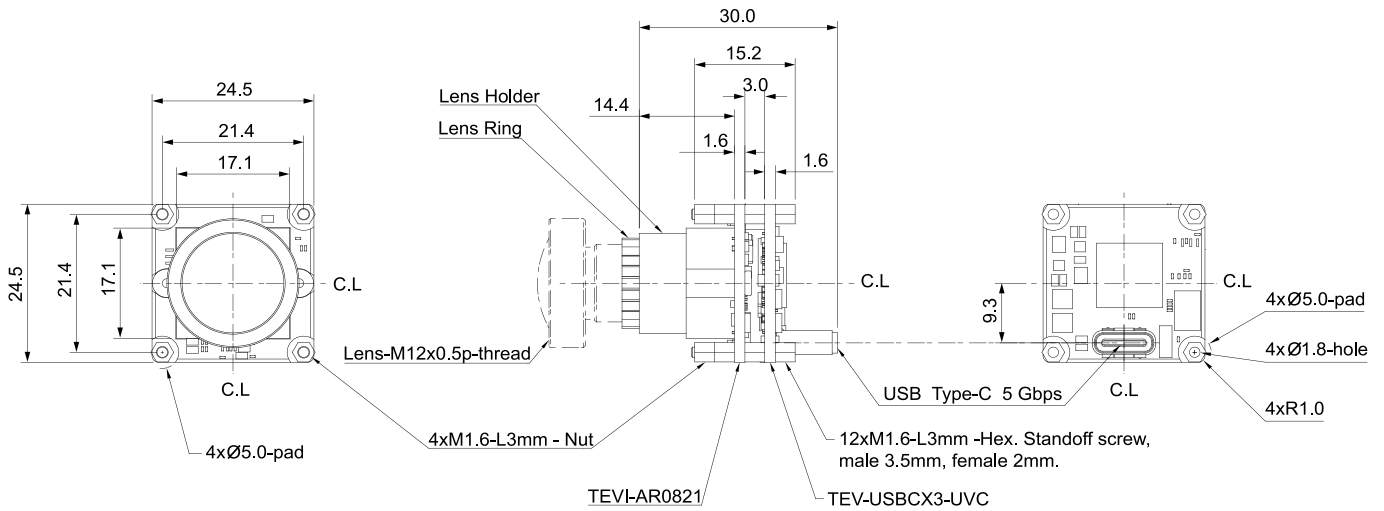

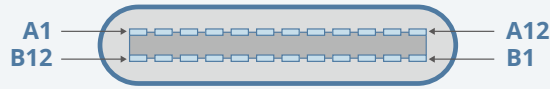

Connector Pin Definition



No.	Pin Define	No.	Pin Define
A1	GND	B12	GND
A2	TXP1	B11	RXP1
A3	TXN1	B10	RXN1
A4	VBUS1	B9	VBUS3
A5	CC1	B8	SBU2
A6	DP1	B7	DN2
A7	DN1	B6	DP2
A8	SBU1	B5	CC2
A9	VBUS2	B4	VBUS4
A10	RXN2	B3	TXN2
A11	RXP2	B2	TXP2
A12	GND	B1	GND

Lens Information

				
	UVCI-AR0821-C-S44-IR	UVCI-AR0821-C-S74-IR	UVCI-AR0821-C-S119-IR	UVCI-AR0821-C-S156-IR
Focus Type	Fixed Focus	Fixed Focus	Fixed Focus	Fixed Focus
Focal Length	12 mm	6 mm	3 mm	3.2 mm
Aperture	F2.0	F2.8	F2.0	F2.0
Module D-FOV	44.0° ± 5%	74.4° ± 5%	118.8° ± 5%	156.0° ± 5%
Module H-FOV	38.3° ± 5%	67.1° ± 5%	110.7° ± 5%	137.2° ± 5%
Module V-FOV	21.6° ± 5%	40.8° ± 5%	75.4° ± 5%	79.4° ± 5%
TTL	23.09 mm	28.6 mm	29.56 mm	44.98 mm
BFL	5.06 mm	8.8 mm	4.85 mm	6.14 mm
MOD	0.15 m	0.1 m	0.3 m	0.3 m
Distortion	<2%	<0.5%	<-5%	<-32%
IR-Filter	650 nm	650 nm	650 nm	650 nm

Order Information

UVCI-AR0821-x-Sxx-xx-xxxx

Option	Code	Description
Chromaticity	C	Color
Lens	S44	S-Mount Module D-FOV 44°
	S74	S-Mount Module D-FOV 74°
	S119	S-Mount Module D-FOV 119°
	S156	S-Mount Module D-FOV 156°
Filter	-	-
	IR	IR Cut Filter 650nm
Custom ID	xxxx	Custom Part number ID for customized Software loader and special component (BOM)

For customization, please contact your TechNexion sales representative.

Optional Accessories

An easy to attach A-Mount bracket for TechNexion camera board modules.



245-MOUNT-BRACKET



245-MOUNT-BRACKET on tripod (tripod not included)